

Sump Pump Control with 8 ft. cord

Model Z24802PTZ SKU# SUMP-RES5

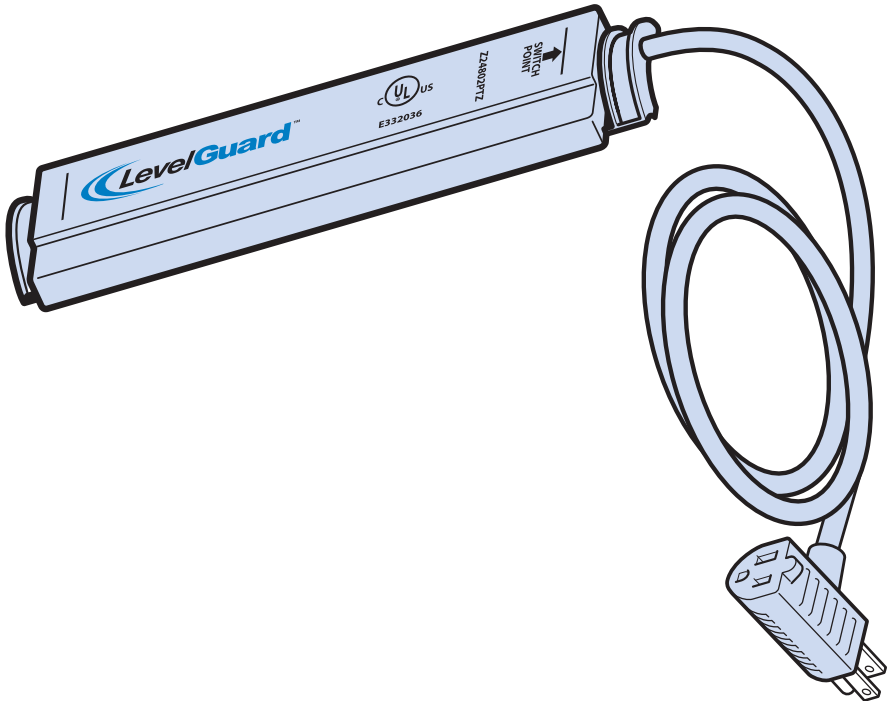

INSTALLATION INSTRUCTIONS

Table of Contents

What is the LevelGuard™ Sump Pump Control?...2	Service & Repair.....12
Features.....2	5-Year Limited Warranty.....12
Will it work with my pump?3	
Important Safety Information..... 4-5	
Installation Instructions.....6	
Remove Existing Switch7	
Install LevelGuard Sump Pump Control.....8	
Electrical Connection.....9	
Test.....10	
Trouble-Shooting.....11	
Maintenance Guide.....12	

WARNING! Read this Operator's Manual carefully prior to using this device. Failure to understand and follow the contents of this manual may result in electrical shock, fire and/or serious personal injury.

What is the LevelGuard™ Sump Pump Control?

LevelGuard™ Sump Pump Control uses patented “Field-Effect” sensing technology to reliably detect water level and solid-state digital switching to replace conventional pump switches, completely eliminating the #1 failure mode in traditional sump pump systems.

Features

- Uses patented “Field-Effect” sensing technology to *detect* water level through the water-tight thermoplastic shell.
- NO MOVING PARTS to wear out or bind.
- Includes fused over-current protection against pump electrical failures.
- Requires less working space than mechanical float switches.
- Reliably controls a 6.7" (170mm) water column.
- Automatic time-delay before turn-on minimizes activation from water sloshing and extends pump life.
- Tested to 1.5 million cycles — outlasts traditional float switches 7 to 1.
- Simple piggyback plug electrical installation — easy replacement for old system.
- RoHS Compliant, UL-Listed.

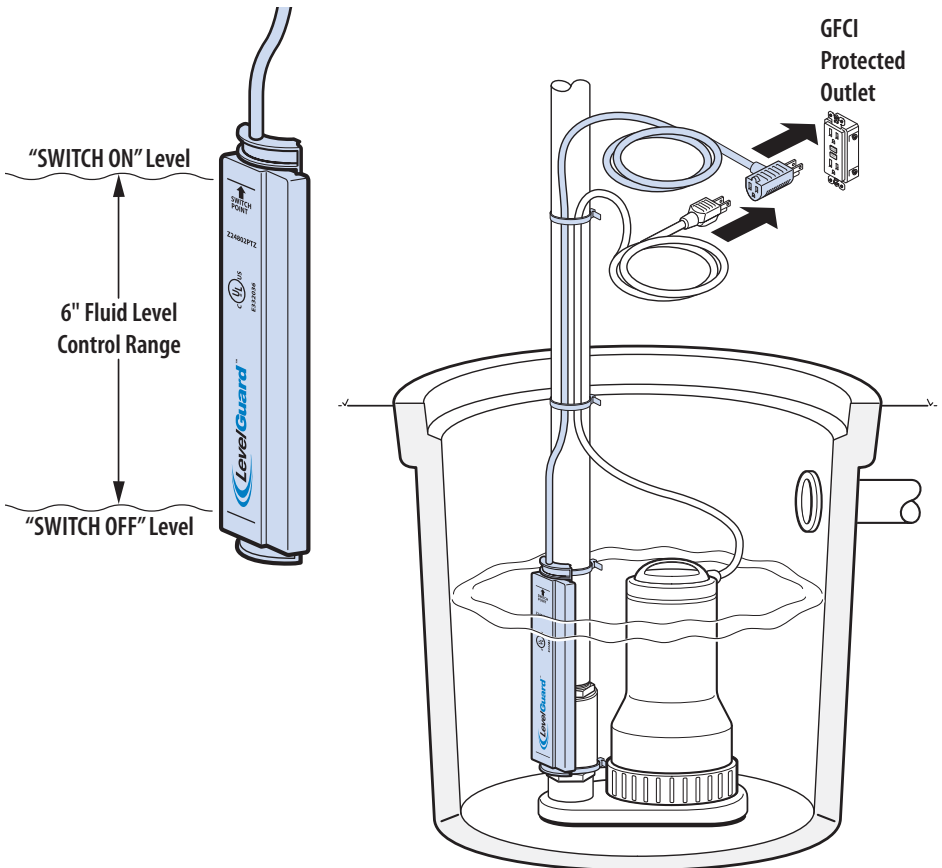

Will it work with my pump?

- LevelGuard™ Sump Pump Control replaces mechanical float-switches on new and existing sump pumps.
- The Sump Pump Control is designed to work with piggyback-plug style electrical systems **ONLY**.
- **DO NOT** use LevelGuard Sump Pump Controls in systems where the switch is directly integrated into the pump.

NOTICE: Since the LevelGuard Sump Pump Control works in combination with an existing pump, you must read and follow the Manufacturer's instructions for that pump. Failure to do so may void the warranty or cause product damage.

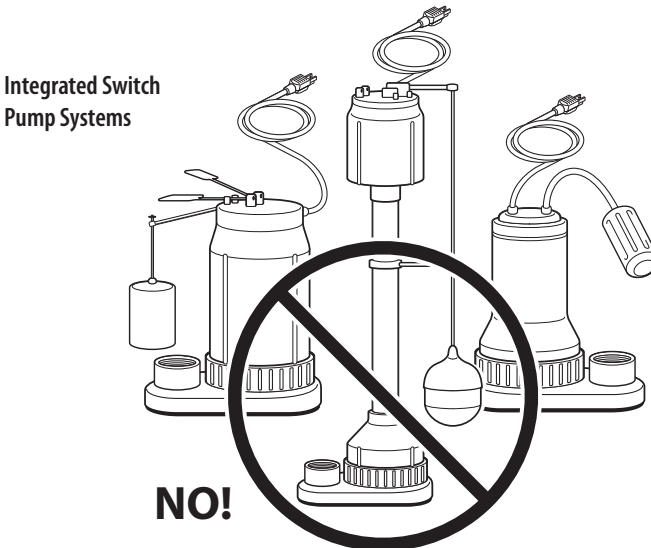
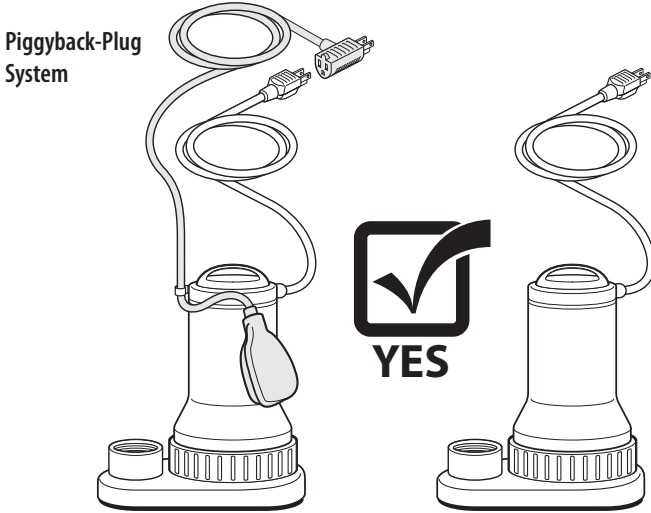

Important Safety Information

SAVE THESE INSTRUCTIONS

Carefully read this manual before installing or using this product. Failure to understand and follow this manual may result in personal injury, electrical shock, and/or fire.

SAFETY SYMBOLS & SIGNAL WORDS

Read and Understand these types of Warnings:

DANGER: means that someone will be injured or killed if the safety information is not followed.

WARNING: means that someone could be injured or killed if the safety information is not followed.

NOTICE: means that property or equipment damage may result if instructions are not followed.

Personal Safety

DANGER: This installation involves use of high-voltage electricity in a wet environment, so please use common sense and caution.

You can safely install the LevelGuard™ Sump Pump Control **ONLY IF YOU:**

- Contact a qualified electrician immediately if sump area is wet or flooded. Do not walk on or touch wet areas until all power is disconnected from pump electrical outlet.
- **DO NOT** touch the sump pump or discharge piping when the pump is connected to electrical power and water is present in the sump pit. Always disconnect the pump from the power source before handling.
- Do not install this product while impaired in any way.
- Do not allow by-standers, children, or pets to come near the installation or cause distraction.
- Keep loose clothing and jewelry away from electrical parts. Use non-skid shoes and proper eye protection.
- Do not operate this electrical device in an explosive atmosphere, such as in the presence of flammable liquids, gases, or dust. The LevelGuard Sump Pump Control is sealed and solid-state, but the pump motor can create sparks that may ignite dust or fumes.

Equipment and Electrical Safety

- Plug the LevelGuard Sump Pump Control **ONLY** into a properly grounded, Ground Fault Circuit Interrupt (GFCI) receptacle.

NOTICE: These instructions assume that local code enforcement requires the use of a GFCI receptacle. (Codes may vary by geographical jurisdiction.)

- GFCI receptacle must be installed by qualified electrician in accordance with all applicable codes and ordinances.
- Before LevelGuard Sump Pump Control installation, a qualified person must test the GFCI to assure that it is operating properly.
- Never remove the grounding prong; never modify the plug or GFCI in any way; do not use any adapter plugs.
- Keep cord away from sharp edges, heat, oil, or moving parts. Discontinue use immediately if cord is damaged.

Application

NOTICE: Since the LevelGuard™ Sump Pump Control works in combination with another Manufacturer's pump, you must read and follow the Manufacturer's instructions for that pump. Failure to do so may void the warranty or cause product damage.

- The LevelGuard Sump Pump Control is designed to work as a water-detecting switch for sump pumps made by other manufacturers.
- Any connected sump pump must operate within the "Performance Specifications" listed below. Improper use, modification, or installation of this device may cause damage to the product and surrounding equipment.
- Includes thermal protection designed to prevent burnouts due to electrical overload.
- Includes fused over-current protection to safe-guard users from pump failure modes resulting in high electrical current.
- LevelGuard Home Sump Pump Controls are designed for residential use only.
- NOT DESIGNED to work in caustic chemical fluids or solutions. DO NOT use for detecting oil, alcohol, or petrochemical solutions. Not warranted to function in mixtures containing heavy foreign materials.
- It is strongly recommended that an alternative system be used to protect against power outages, excessive water flow, GFCI tripping, and primary pump failure.

Performance Specifications

- For use ONLY with 120-VAC, 60Hz, single-phase current only. Do not use with 240VAC systems.
- Current draw while in operation: 1.3 milliamps.
- Circuit Requirement: 15 amp dedicated branch circuit.
- Load Current Rating: 120VAC/12 amps continuous; ½ hp/D150 (72VA).
- Sensor Technology: Solid-State "Field-Effect".

Environmental

- Ambient Operating Temperature: 0°C to 50°C; Storage Temperature: -40°C to 85°C.
- Ambient Liquid Operating Temperature: 0°C to 50°C.

Construction

- Housing Material: Plastic.
- Cord: SJTOW/14 Gauge. Includes piggyback female plug to receive cord from (and switch power to) sump pump.
- Standard Cable Length: 8 ft (Model Z24802PTZ).
- Water Level turn on/ turn off range: approx. 6.7" (170mm) typical differential, non-adjustable.

Certifications

- UL E332036, CUL E332036.
- RoHS Compliant.

Installation Instructions

Unpack Materials

Contents of the package include:

- LevelGuard™ Sump Pump Control with 8' cord
- Attachment Straps, quantity five (5)
(Sump pump not included)

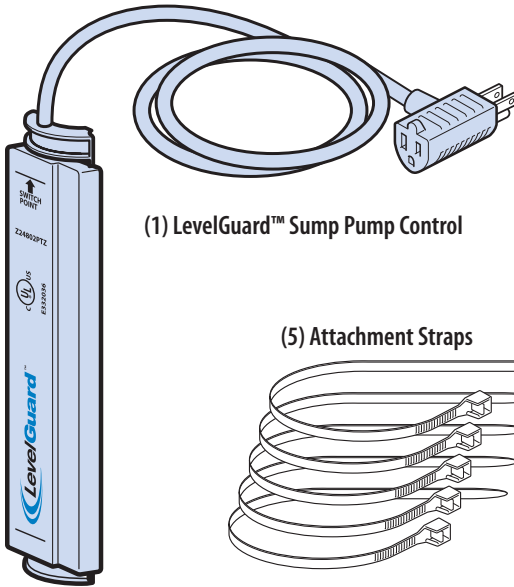

(1) LevelGuard™ Sump Pump Control

(5) Attachment Straps

Tools Required

In addition to the product, you may need:

- Cutters to trim ends of tie straps
- Screwdriver (slotted or Phillips, as required) to remove old tethered float switch from pump.
- Tape measure

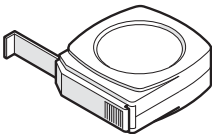

Tape Measure

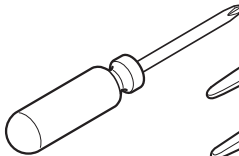

Screwdriver

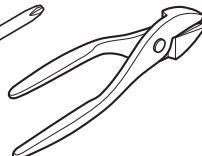

Cutters

Remove Existing Switch (optional; not required for new installations using pumps which do not include switch function)

DANGER: Be positive that electrical power is disconnected from all circuits near the sump pump. Contact a qualified electrician if necessary.

1. Shut off power to sump pump circuit.
2. Unplug sump pump and existing switch from outlet.
3. Remove sump pump from sump pit (optional).
4. Remove retaining screw(s) to disconnect existing tethered switch. Discard old switch.
(Actual procedure may differ from illustration and is dependent on your pump make and model.)
5. Reinstall sump pump into pit.

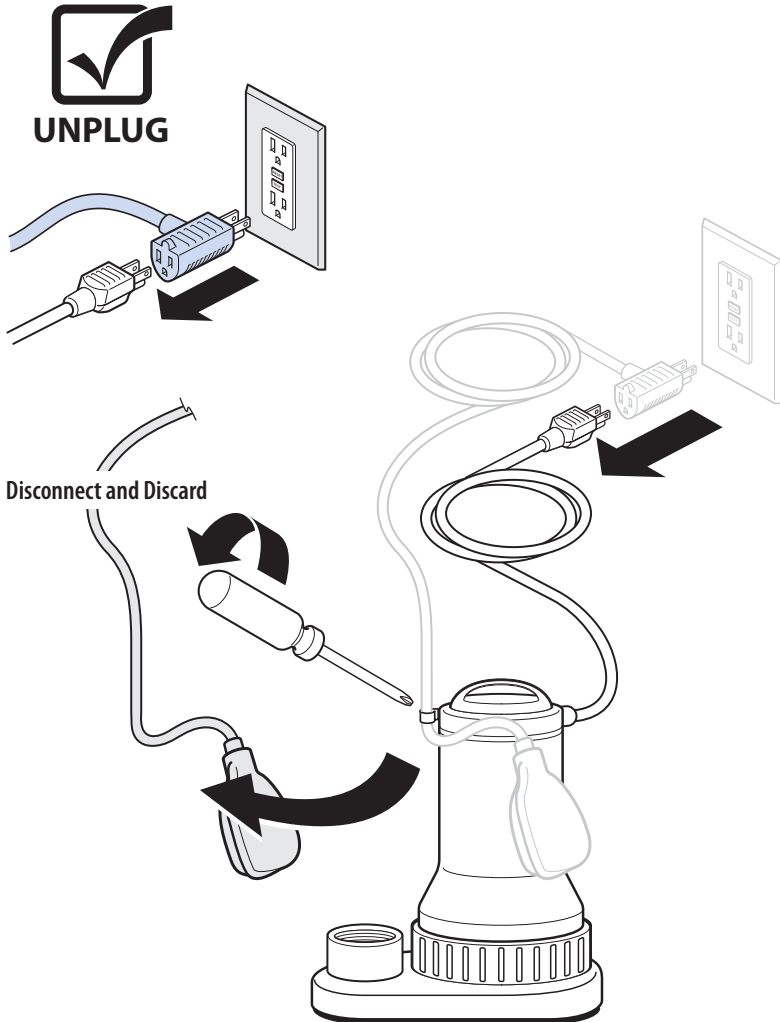

Install LevelGuard™ Sump Pump Control

WARNING: DO NOT plug in LevelGuard™ Sump Pump Control until instructed to do so.

1. Drain the sump pit (Recommended).
2. Loop provided tie straps through LevelGuard Sump Pump Control holes at top and bottom as shown in Detail A. Leave about 3" of slack for ease of installation.
3. Hold Sump Pump Control with cord up. Lower it into sump pit.
4. Place bottom of Sump Pump Control against discharge pipe, at **LOWEST** level where you want water to be pumped. This is where the Sump Pump Control turns the pump "OFF".

NOTICE: If check valve is in the way, you can attach Sump Pump Control onto the check valve (Detail B). Mount Sump Pump Control facing **AWAY** from inlet pipe.

5. The Switch Point "ON" is 6.7" (170mm) above "OFF" level... so water will rise about 6" before pump turns on.
6. Be certain that outward face of Sump Pump Control has 2" (51mm) **MINIMUM CLEARANCE** from any foreign objects.
7. Securely fasten top and bottom of Sump Pump Control to discharge pipe by tightening the two tie straps (do not overtighten.)

Detail A

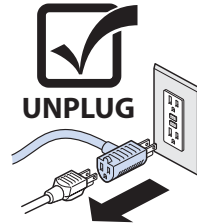
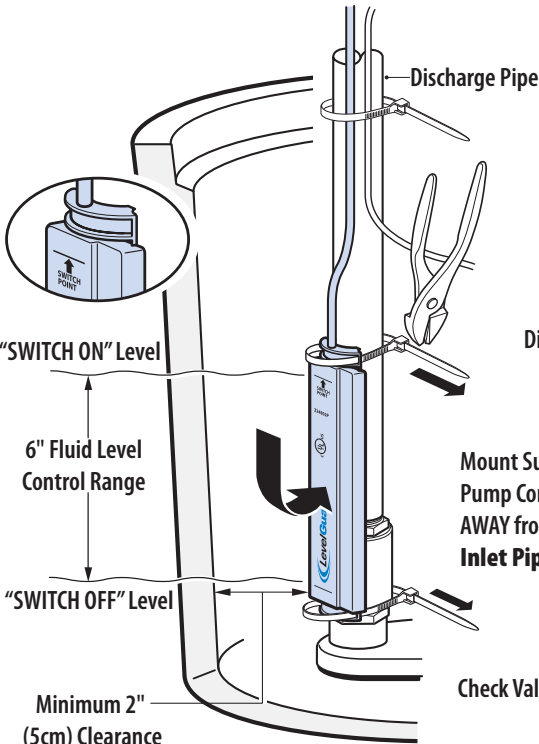
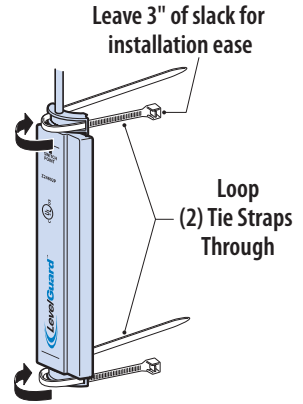

Detail B

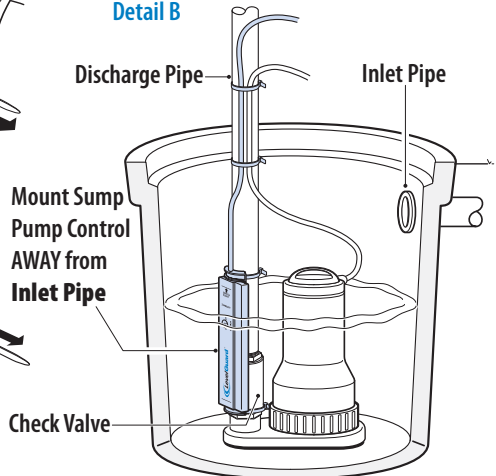

Electrical Connection

WARNING: Perform ALL cord management and routing BEFORE turning on main power and before you plug into the GFCI outlet.

1. Find a path where sump pump and LevelGuard™ Sump Pump Control cords will be protected from all sharp objects, hot surfaces, oils, and chemicals.
2. Use provided tie straps to fasten cords to the discharge pipe.

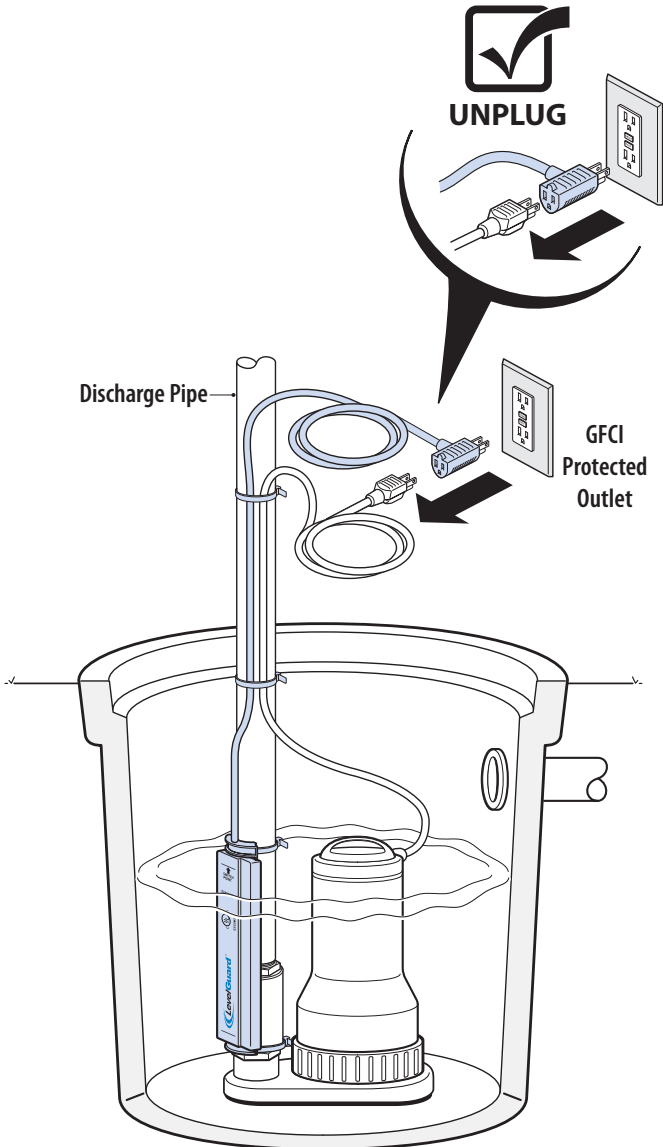

3. Plug pump cord into back of the LevelGuard™ Sump Pump Control piggyback plug.

DANGER: The Ground Fault Circuit Interrupt (GFCI) receptacle must be installed by a qualified electrician in accordance with all applicable codes and ordinances.

Before you connect to the GFCI, a qualified electrician must test the GFCI to assure that it is operating properly.

4. Insert Sump Pump Control plug ONLY into a GFCI ground-fault protected outlet that is operating properly.

5. Recheck plugs for firm connection.

6. Turn Main Power to circuit "ON".

Test

1. Allow water to fill the sump pit up to the Switch "ON" Point on the LevelGuard Sump Pump Control.

2. Sump Pump Control "Turns ON" the pump two (2) seconds after water rises to the "Switch On" Point. Sump Pump Control "Turns OFF" when water is pumped to bottom of the Control "Switch Off" Point.

If pump does not operate:

- TURN OFF electrical circuit that supplies the GFCI receptacle.
- Re-check plugs for firm connection.
- Reset GFCI receptacle.
- Re-connect electrical circuit.
- Consult "Trouble-Shooting" chart if problems continue.

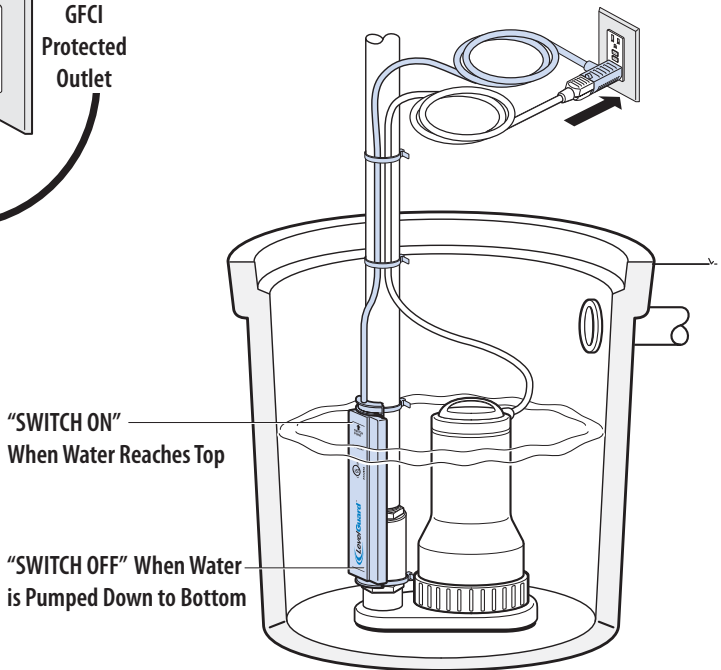
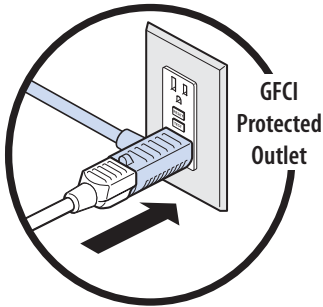

Trouble-Shooting for LevelGuard™ Sump Pump Control

Symptom	Possible Root Cause(s)	Potential Corrective Action
Pump will not start or run	<ol style="list-style-type: none"> 1. Sump Pump Control cord improperly plugged into receptacle. 2. Pump cord improperly plugged into Sump Pump Control plug. 3. Blown panel fuse or breaker. 4. GFCI receptacle tripped. 5. Low Voltage. 6. Main Power Outage. 7. Defective Pump. 8. Contamination build-up on Sump Pump Control exterior. 9. Improper Mounting / Loose. 10. Damaged or defective Sump Pump Control. 	<ol style="list-style-type: none"> 1. Properly insert plug into receptacle. 2. Properly insert pump cord into Sump Pump Control piggyback plug. 3. Replace with proper sized fuse or reset breaker. 4. Reset GFCI receptacle. 5. If voltage under 108 volts, contact qualified electrician. 6. System will not work without power. 7. See Pump Manufacturer's Operators Manual. 8. See Maintenance Guide for proper cleaning instructions. 9. See Sump Pump Control Installation Instructions. 10. Contact LevelGuard Customer Service.
Pump starts and stops too often	<ol style="list-style-type: none"> 1. Significant in-flow of water. 2. Sump Pump Control mounted facing inlet pipe. 3. Defective check-valve. 4. Defective Pump. 5. Excessive Temperature. 6. Improper Mounting / Loose. 7. Damaged or defective Sump Pump Control. 	<ol style="list-style-type: none"> 1. Normal. Check Pump Specification to confirm adequate pumping capacity. 2. Move Sump Pump Control away from inlet pipe. 3. Replace check-valve. 4. See Pump Manufacturer's Operator Manual. 5. Let system cool down for 5 minutes. 6. See Sump Pump Control Installation Instructions. 7. Contact LevelGuard Customer Service.
Pump will not shut off when water is not present at the lower limit	<ol style="list-style-type: none"> 1. Contamination build-up on Sump Pump Control exterior. 2. Improper Mounting / Loose. 3. Foreign conductive object near sensor pad. 4. Damaged or defective Sump Pump Control. 	<ol style="list-style-type: none"> 1. See "Maintenance Guide" for proper cleaning instructions. 2. See Sump Pump Control Installation Instructions. 3. Remove foreign object. 4. Contact LevelGuard Customer Service.

Maintenance Guide

WARNING: Unplug LevelGuard™ Sump Pump Control and Pump from all electrical power BEFORE doing any service or maintenance.

- Inspect area around Sump Pump Control and clear all foreign objects and buildup.
- Plug Sump Pump Control and Pump back into GFCI wall outlet after inspection. Check for proper operation.
- We recommend that you do this maintenance at least once a year. However, harsh environmental conditions will dictate the necessity of your actual maintenance schedule.

GFCI Receptacle

NOTICE: The recommended use of a GFCI receptacle is meant for your protection. As part of its designed function, a GFCI receptacle can “trip” (turn off power supply) in cases of ground faults.

Because the GFCI receptacle can trip and cut off power to the pump, we recommend that you FOLLOW THE RECEPTACLE MANUFACTURER’S INSTRUCTIONS for test and reset procedures.

Service & Repair

- The LevelGuard Sump Pump Control contains NO serviceable parts.
- Do not disassemble Sump Pump Control. Doing so can result in death or electrical shock and voided warranty.
- If Sump Pump Control stops working, refer to troubleshooting instructions provided in this manual.
- If part is under warranty, follow warranty instructions provided in this manual or visit us at www.LevelGuardProducts.com.
- If part is not under warranty, disposal of unit is necessary following local and or regional codes.

5-Year Limited Warranty

The LevelGuard™ Sump Pump Control is warranted for five (5) years from date of purchase, for manufacturer’s defects ONLY.

Up to five (5) years from date of purchase, TouchSensor Technologies will replace, at its option, for the original purchaser any part or parts of its LevelGuard™ Sump Pump Control (“Product”) found upon examination by TouchSensor Technologies to be defective in materials or workmanship. Be prepared to provide the complete product and proof of purchase receipt and completed warranty claim form when exercising this warranty. All transportation charges on Products or parts submitted for evaluation or replacement must be paid by purchaser.

This Limited Warranty does NOT cover products which have been damaged as a result of accident, abuse, misuse, neglect, improper installation, improper maintenance, pump failure resulting in an over-current electrical condition, or failure to operate in accordance with LevelGuard™ written instructions.

THERE IS NO OTHER EXPRESS WARRANTY, IMPLIED WARRANTIES, INCLUDING THOSE OF MERCHANTABILITY AND FITNESS FOR A PARTICULAR PURPOSE, OR LIFETIME WARRANTY FROM THE DATE OF PURCHASE. THIS IS THE EXCLUSIVE REMEDY AND ANY LIABILITY FOR ANY AND ALL INDIRECT OR CONSEQUENTIAL DAMAGES OR EXPENSE WHATSOEVER IS EXCLUDED.

In no event, whether as a result of breach of contract warranty, tort (including negligence) or otherwise, shall TouchSensor Technologies or its suppliers be liable for any special, consequential, incidental or penal damages including, but not limited to loss of profit or revenues, loss of use of the products or any associated equipment, damage to associated equipment, cost of capital, cost of substitute products, facilities, services or replacement power, downtime costs, or claims of buyer’s customers for such damages.

In the event that you need to exercise a warranty claim, please visit our website at www.LevelGuardProducts.com to attain electronic copies of the warranty claim forms and instructions relating to the claim submission process.

How to Contact TouchSensor Technologies for warranty related information

Call our customer care center at 1-877-342-3261 (From Canada, call 1-630-221-9000)

Or write us at: Customer Care Center	Proof of Purchase & Product Information
TouchSensor Technologies	Store Name _____
c/o LevelGuard™ Products	Date Purchased _____
203 North Gables Blvd.	Model Number _____
Wheaton, IL 60187	Serial Number _____
levelguard@touchsensor.com	